

# CHFV SERIES 31A/35A MINIATURE POWER RELAY

## FEATURES

- Outline dimension (30.1mm×15.7mm×26.5mm)
- PCB terminal
- 1 Form A (SPST) contact arrangement
- Designed to meet cULus,TUV,CQC requirements
- 4,500VAC Dielectric strength between coil and contact
- Contact GAP 2.0mm Min.
- RoHS compliance
- REACH SvHC compliance



File NO. E341422



File NO. R50220099



File NO. CQC1100206606

## APPLICATION

Solar Inverter, AC Power Supply, Washing Machine...etc

## COIL PARAMETER

Coil voltage	9-24VDC
Coil power	1.4W

## COIL DATA@23°C

CHE				
Nominal coil voltage (VDC)	Nominal Current (mA)	Coil Resistance (Ω±10%)	Operate Voltage (VDC Max.)	Release Voltage (VDC Min.)
9	155.6	58	6.75	0.45
12	116.7	103	9	0.60
18	77.8	231	13.5	0.90
24	58.3	411	18	1.20

## CONTACT DATA

Contact arrangement	1 Form A(SPST)
Contact material	Ag Alloy
Initial contact resistance	100mΩ max.@6VDC,1A
Max. switching voltage	277VAC
Max. switching current	35A
Max. switching power	9,695VA
Contact rating	20A 250VAC/277VAC,Resistive
	31A 250VAC/277VAC,Resistive
	35A 250VAC/277VAC,Resistive
	20A 250VAC/277VAC,Inductive(cos Φ =0.8)
	31A 250VAC/277VAC,Inductive(cos Φ =0.8)
	35A 250VAC/277VAC,Inductive(cos Φ =0.8)
Mechanical endurance	500,000 ops Min.(no load)
Electrical endurance	30,000 ops Min(rated load )
Minimum load(reference value)	100mA @5VDC

## CHARACTERISTICS

Operate voltage	75% of nominal voltage or less	
Release voltage	5% of nominal voltage or more	
Operate time (At nominal voltage)	20ms max.	
Release time(At nominal voltage)	10ms max.	
Insulation resistance	1,000 MΩ min. (at 500 VDC)	
Dielectric strength	Between coil and contacts	4,500 VAC, 50/60 Hz for 1 min
	Between open contacts	2,800 VAC, 50/60 Hz for 1 min
Surge voltage between coil and contacts	10,000V(1.2/50us)	
Vibration resistance	Destruction	10 to 55 Hz,1.5mm double amplitude
	Malfunction	10 to 55 Hz,1.5mm double amplitude
Shock resistance	Destruction	1,000m/S <sup>2</sup> (100G approximately)
	Malfunction	100m/S <sup>2</sup> (10G approximately)
Ambient temperature	-40°C ~ +85°C (without icing or condensation)	
Ambient humidity	5%~85% RH	
Terminal	PCB terminal	
Enclosure (94V-0 Flammability Ratings)	V:	Vented(Flux-tight),plastic cover.(RT II)
	S:	Sealed,plastic cover.(RT III)
Weight	Approx. 23g	

## ORDERING INFORMATION

	CHFN	-V	-1	12	H	A	2	F	(35A)	000
1. Product Family	CHFN									
2. Enclosure	V = Vented(Flux-tight , RT II) S = Sealed(Wash-tight, RT III)									
3. Number of Poles	1 = 1 pole									
4. Rated Coil Voltage	09 = 9VDC 12 = 12VDC 18 = 18VDC 24 = 24VDC									
5. Coil Input	H = High Capacity Type(1.4W)									
6. Contact Arrangement	A = Form A (SPST-NO)									
7. Contact material	2 = AgSnO <sub>2</sub>									
8. Insulation System	F or Blank=Class F(155°C)									
9. Nominal Current	(35A)=Nominal Current 35A (31A)=Nominal Current 31A									
8. Additional numbers and /or letters	000-999 , AAA-ZZZ , aaa-zzz or blank , which does not represent electrical changes, only for specific customer requirements									

## OUTLINE DIMENSION

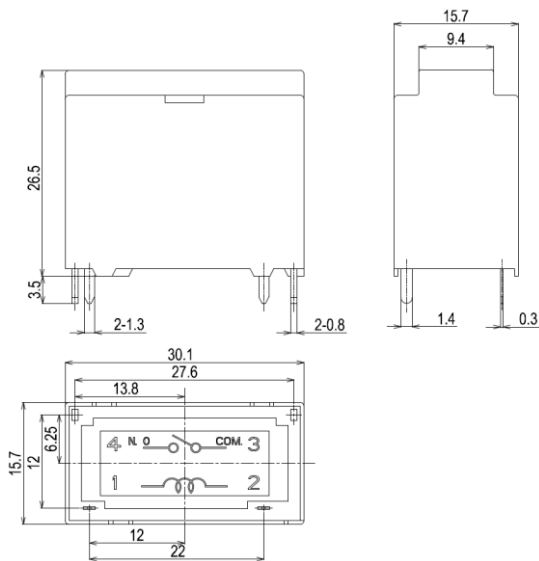

### Remark:

- The reference tolerance in outline dimension:
  - outline dimension  $\leq 1\text{mm}$ , reference tolerance is  $\pm 0.2\text{mm}$ ;
  - outline dimension  $> 1\text{mm}$  and  $\leq 5\text{mm}$ , reference tolerance is  $\pm 0.3\text{mm}$ ;
  - outline dimension  $> 5\text{mm}$ , reference tolerance is  $\pm 0.5\text{mm}$ .
- The reference tolerance for PC Board layout is  $\pm 0.1\text{mm}$ .

## WIRING DIAGRAMS (BOTTOM VIEWS)

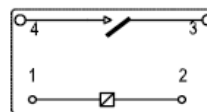

## PC BOARD LAYOUTS (BOTTOM VIEWS)

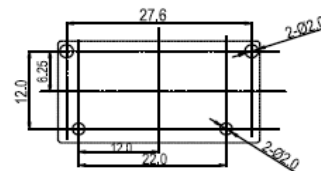

## Reference Date

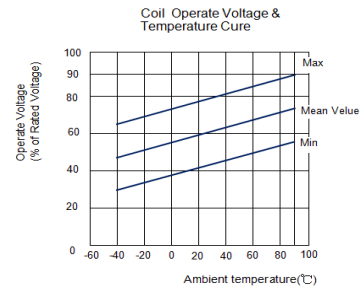
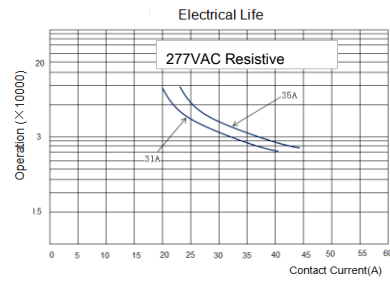
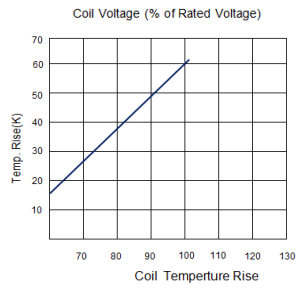

## PACKAGING FIGURE

1.Box

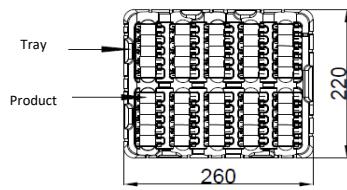

50 pcs inside a box

500 pcs inside a carton

Disclaimer:

The specification is for reference only, if you need more detail information, please contact Churod. We could not evaluate all the performance and all parameters for every possible application.

And the user should be in a right position to choose the suitable product for their own application. If there is any new need, please contact Churod for the technical service.

[Http://www.churod.com](http://www.churod.com)

2020 Rev.00 Churod Electronics Co., Ltd.